

ÓLEO DO MOTOR



TC-3051

Cód.: 3002 252

Tampa do Óleo Motor Del Rey / Escort / Gol / Voyage / Apollo / Saveiro (c/ Motor CHT)



TC-3050

Cód.: 3002 690

Tampa do Óleo Motor Gol / Voyage / Parati / Santana / Saveiro / Pointer / Logus / Apollo Polo / Golf / Passat / Audi 80, 100, A3, A4, A6 e A8 / Escort Verona motor AP / Mercedes todos com tampa de Plástico



TC-4052

Cód.: 5004 238

Motores Fire: 1.0; 1.3 e 1.4 - 8V
TODOS



TC-4046

Cód.: 5004 225

Tampa de Óleo do Motor Palio / Strada (1.0 / 1.5 / 1.6 / 8 Válvulas) Fiorino Até 97 / Siena (1.0 / 1.5) todos



TC-4047

Cód.: 5004 226

Tampa de Óleo do Motor Fiorino Tipo após 97 / Siena (1.6 8V) e Brava 1.8



Cód.: 0352 282 35

Anel da tampa do óleo do motor Palio / Strada / Siena Motor Fire 8V



TC-4044

Cód.: 5004 237

Tampa de Óleo do Motor Palio Strada / Siena Motor Fire 8V



TC-5019

Cód.: 6002 011

Tampa do Óleo Motor Opalla / Chevette Após 80



TC-5056

Cód.: 6002 630

Tampa do Óleo Motor Monza / Kadett / Corsa / Celta / Vectra / Astra Até 96 / S-10 4 cil.



TC-5020

Cód.: 6002 631

Tampa do Óleo Motor Corsa / Tigra 1.0 / 1.6 16V



TC-3052

Cód.: 3002 041

VW: Fusca, Kombi, Brasília, Gol, Saveiro, Variant e TL (motores à ar)
MBB: Caminhões



TC-5015

Cód.: 6002 632

Tampa do Óleo Motor Astra Vectra / S-10 / Blazer 97



TC-5016

Cód.: 6002 633

Tampa do Óleo Motor Astra / Vectra Após 97 16V



TC-1050F

Cód.: 7001 002

Tampa do Óleo Motor Mercedes Benz - Todos



TC-1030F

Cód.: 4003 331

Motor PERKINS Trator e D-20

RADIADOR



TC-3060

Cód.: 3002 250

Tampa do Reserv. D' Água do Radiador Voyage / Parati / Gol / Saveiro / Santana / Escort / Verona / Pampa 1.8 / Versailles / Royale (todos 90/...) Audi 80 / A4 (1,5 bar)



TC-7018

Cód.: 3002 251

Tampa do Radiador Passat / Voyage / Parati / Gol / Santana / Quantum / 14 LBS



TC-3061

Cód.: 3002 633

Tampa do Reservatório de Expansão Gol e Parati Geração III / Golf 97 / Passat 96 / Polo / Van / Caravelle / Eurovan / SEAT Cordoba / Ibiza / Toledo Inca



TC-3062

Cód.: 3002 634

Tampa do Reservatório de Expansão Golf 98 / Passat Importado / Audi A6 97 / A3 / A4



TC-7000

Cód.: 4003 051

Tampa da Bomba D' Água Escort / Verona / Pampa / Gol Voyage / Parati (Motor CHT)



TC-7006F

Cód.: 4003 052

Tampa do Radiador F-1000 / F-4003 / F-11000 / F-22000 A-10 / D-10 / C-14 / D-20 / D-60 / D-70 / Valmet Massey Ferguson / Perkins (7 Libras)



TC-7010F

Cód.: 4003 053

Tampa do Radiador FORD Cargo (7 Libras)



TC-6300

Cód.: 4003 299

Tampa do Reservatório D' Água Radiador Escort 97 / KA / Fiesta / Courier / Mondeo (1,2 bar)



TC-7015

Cód.: 4003 300

Tampa do Reservatório D' Água do Radiador F-1000 96 / F-12000 / 14003 Ford Cargo / Ranger 97 e VW Caminhão (1,0 Bar)



TC-4041

Cód.: 5004 141

Tampa do Reservatório D' Água do Radiador Uno Prêmio / Elba / Fiorino / Pick-up Tempra / Palio (1,0 bar)



TC-4051

Cód.: 5004 229

Tampa do Reservatório D' Água do Radiador Marea Brava / Palio / Siena / Strada (Fire 8V / 16V) (1,4 bar)



TC-7014

Cód.: 6002 037

Tampa do Radiador Verona / Escort / Apollo / Caminhão Ford Opala Até 84 / C-10 / D-10 / D-20 (13 Libras)



TC-5050

Cód.: 6002 039

Tampa do Reservatório D' Água do Radiador Monza / Kadett / Chevette / Omega Vectra / Corsa (1,0 bar)



TC-6400

Cód.: 6002 561

Tampa do Reservatório D' Água do Radiador Trafic / Clio / Mégane / Laguna Scénic / Express (1,2 bar)



TC-7009F

Cód.: 7001 001

Tampa do Radiador MBB: 608 OM, 1113 e 2013 ano 88>>



TC-7000

Cód.: 6002 040

Tampa do Radiador Opala - 85 -> 92

TANQUE DE COMBUSTÍVEL



TC-3100

Cód.: 4003 297

Tanque Combustível Versailles e Royale 90 em Diante Voyage Parati 87/89/90 em Diante / Gol Santana / Quantum 90/...



TC-3080

Cód.: 3002 400

Tanque Combustível Gol e Saveiro 90 -> 96 Kombi 90 -> 05/98 Álcool / Gasolina



G5007

Cód.: 4003 298

Tampa do Tanque Combustível Ford F-4003 / Chevrolet D10 / D20



TC-4021

Cód.: 5004 241

Tanque Combustível Palio todos



TC-3100

Cód.: 6002 222

Tampa do Tanque Combustível Monza / Kadett / A-20 / C-20 / D-20 Após 90 / Ipanema 90/92 / Blazer / Voyage / Parati / Santana Após 90 / Gol Bola



TC-3100S

Cód.: 6002 223

Tampa do Tanque Combustível s/ Chave Corsa todos



TC-3100

Cód.: 6002 224

Tampa do Tanque Combustível c/ Chave Corsa todos / Versailles / Royale Após 90



G5007

Cód.: 4003 295

Tanque Combustível Pick-Up F-1000 / Corcel II Todos / Del Rey Todos / Passat / Santana e Quantum



TC-3030

Cód.: 4003 296

Voyage e Parati 82 -> 86 / Gol e Saveiro 80 -> 89 Kombi 09/81 > 89 / Álcool / Gasolina Saveiro Diesel - 10/84 -> 10/97

TANQUE DE COMBUSTÍVEL



TC-1008

PRETA

Cód.: 7001 160

Tampa do Tanque Combustível Scania / Volvo todos / Mercedes Bens (a partir de 90 todos)



CROMADA

Cód.: 7001 161

Tampa do Tanque Combustível Mercedes Bens.../ 89/ Ford Cargo / FNM / VW / Agrale todos (Inclusive tanques BEPO)



D1004S

Cód.: 7001 162

Tampa do Tanque Combustível Mercedes Bens.../ 89/ Ford Cargo / FNM / VW / Agrale todos (Inclusive tanques BEPO)



D1004

PRETA

Cód.: 7001 158

Tampa do Tanque Combustível Mercedes Bens.../ 89/ Ford Cargo / FNM / VW / Agrale todos (Inclusive tanques BEPO)



D1015

Cód.: 7001 170

Tampa do Tanque Combustível Mercedes Bens (Tanque Plástico c/ Rosca Externa na tampa)



TC-1014

Cód.: 7001 171

Tampa do Tanque Combustível Mercedes Bens (Tanque Plástico c/ Rosca Interna na tampa)



TC-1014S

Cód.: 8000 198

Tampa do Tanque Combustível Scania após 98 Tampa c/ Rosca



TC-1020

Cód.: 7001 172

FORD-VW-SCANIA-VOLVO-AGRALE
FORD Cargo - 02-> F-4000 - 05->
VW-Caminhões, Ônibus, Micro-Ônibus
SCANIA Série IV (114) 97 ->
Para tanque com rosca interna



TC-1012

Cód.: 7001 173

Caminhões NL-10 e NL-12
Ônibus B-7, B-10 e B-58
Número: 68.85.815
68.85.800 (Ref)



TC-1010

Cód.: 7001 174

SCANIA Série II (112) -> 09/91
Número: 1.670.531



TC-1022

Cód.: 7001 175

Linha Fiat Iveco
(Exceto Daily Furgão)
Para tanque com rosca interna
Número: 92828166 / 93829326



D1005

Cód.: 7001 176

MBB: Linha Axor (Bocal 105 mm)
Volvo: 320, 360, 380, 400 e 420
FH Ref. MBB: 000.470.04.05
Ref. Volvo: 203.927.50



Cód.: 0161 14x15

Bujão do Carter VW Refrigerado AR
Chave Combinada 21 mm



Cód.: 0333 14x20

Arruela de Cobre c/ Amianto (14 x 20mm)



Cód.: 0171 18 15

Bujão Carter Marea
Chave Allen 8 mm

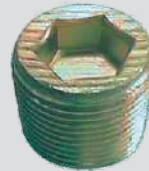

Cód.: 0171 22 15

Bujão do Carter Uno Prêmio / Fiorino / Pálio
Chave Allen 12 mm



Cód.: 0173 22 15

Bujão c/ imã do Câmbio Uno Prêmio / Fiorino
Chave Allen 12 mm



Cód.: 3171 24

Bujão do Câmbio com Imã VW



Cód.: 3173 14 155

Bujão Carter Gol G3 / G4 / G5
Chave Allen 8 mm.



Cód.: 3173 14x15

Bujão do Carter Gol / Parati / Santana
chave allen 6 mm

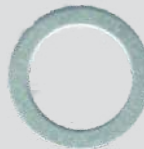

Cód.: 0340 14x20

Arruela do Bujão do Carter Gol / Parati / Santana



Cód.: 3173 24

Bujão do Câmbio s/ imã VW



Cód.: 4171 14x17

Bujão do Carter do Motor Corcel I
Chave Combinada 13 mm

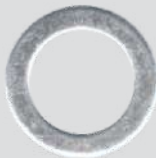

Cód.: 0340 14x22

Arruela de Alumínio 14x22 mm



Cód.: 4171 14x215

Bujão do Carter do Fiesta / Courier / com anel
Chave Combinada 13 mm



Cód.: 4352 19x3

Anel Oring do Bujão do Carter do Fiesta / Courier

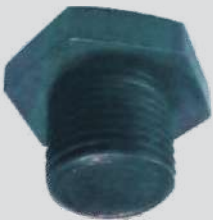

Cód.: 4171 18x14

Bujão do Carter do Motor Corcel I
Chave Combinada 27 mm

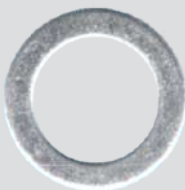

Cód.: 0340 18x26

Arruela de Alumínio 18x26 mm



Cód.: 4171 20x14

Bujão do Carter do Motor MWM
Chave Combinada 19 mm



Cód.: 0340 21x26

Arruela de Alumínio 21,2 x 26 x 1,5 mm



Cód.: 5171 16x141

Bujão do Carter do Peugeot 105/106/206



Cód.: 0340 16x22

Arruela de Alumínio 16x22 mm



Cód.: 5171 16x20

Bujão do Carter do Renault (todos)



Cód.: 0340 16x22

Arruela de Alumínio 16x22 mm



Cód.: 0340 13 19

Arruela de Alumínio (13 x 19mm)
P/ Bujão Opalla



Cód.: 6161 14 14

Bujão do Carter
Chevette / Monza / Corsa / Celta
Chave Combinada 19 mm



Cód.: 0340 14 20

Arruela de Alumínio (14 x 20mm)
P/ Bujão Chevette / Monza / Corsa



Cód.: 6173 14 15

Bujão do Carter c/ Anel
Astra / Vectra Todos
Chave Torx T-45



Cód.: 6352 16 3

Anel de Vedação do Bujão Carter
Vectra Todos



Cód.: 0340 16 22

Arruela de Alumínio (16 x 22mm)
P/ Bujão Trafic Todas



Cód.: 6171 34 19

Bujão do Carter D-20 / D-40 / D-60
Motor Perkins
Chave Combinada 28 mm



Cód.: 0340 20 26

Arruela de Alumínio (20 x 26mm)
P/ Bujão Perkins



Cód.: 5171 12 14

Bujão Carter
Corolla M-12X14X1,25
Chave Combinada 14 mm



Cód.: 0340 12 20

Arruela de Alumínio (12 x 20mm)
P/ Bujão Corolla



Cód.: 5171 14 12

Bujão Carter
Honda Civic / Accord 14X12
Chave Combinada 17 mm



Cód.: 0352 14 26

Anel de Borracha (14 x 26mm)
P/ Bujão Honda Civic



Cód.: 6173 12 254

Bujão do Carter
S-10 / Blazer com anel
Sext. 12x25,5



Cód.: 0333 16X22

Arruela de Cobre com Amianto
16 x 22 mm



Ponteira Hidráulica Fina T/ Combate P/ ser Usada nas Bombas Manuais de Lubrificar. Diâmetro Reduzido: 1/2" Rosca 1/8 NPT.

0486 007



Ponteira Hidráulica Fina T/ Hallbauer P/ ser Usada nas Bombas Manuais de Lubrificar. Diâmetro Reduzido: 9/16" Rosca 1/8 NPT.

0486 008



Ponteira Hidráulica Universal Média Blindada, de Alta Resistência, P/ ser Usada Tanto nas Bombas Manuais como nos Comandos de Graxa Diâmetro: 5/8" Rosca Fêmea: 1/8 NPT.

0486 009



Ponteira Hidráulica Universal Reforçada Indicada P/ Trabalhos de Lubrificação que Requerem o uso de Propulsoras ou Graxeiras Pneumáticas. Garras Reversíveis Rosca Fêmea: 1/8 NPT.

0486 010



Extensão Rígida em Tubo de Aço, P/ Altas Pressões Utilizada nas Bombas Manuais e nos Comandos de Graxa Comprimento: 6" Roscas: 1/8 NPT Macho nos Dois Lados.

0486 011

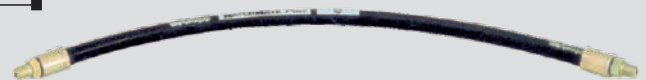

Extensão Flexível com Trama de Aço 1/8 x 1/8. Comprimento: 500 mm

0486 012



Extensão Flexível com Trama de Aço 1/8 Fêmea x 3/8. Comprimento: 1,30 Metros.

0486 013



Bomba de Graxa Manual Capacidade: 500 gramas Alta Pressão: 10.000 Libras.

0486 014



Bomba Manual de Graxa Capacidade: 7 Kg. Pressão: 6.000 Libras Acompanha Mangueira Extensão Rígida e Acoplador.

0486 015



Seringa P/ Sucção de Óleo. Coloca ou Extrai Óleo na Caixa de Câmbio. Capacidade: 500 ml

0486 016



Comando de Óleo Lubrificante

0486 017



Comando de Graxa

0486 022



Chave Saca-Filtro Corrente em Aço Especial Regulável

0486 021

SACA FILTRO DE ÓLEO**COD. 0515 483**

Chave saca filtro de cinta
cabo curto palio fire

SACA FILTRO DE ÓLEO

0,40 kg

COD. 0515 484

Saca filtro de óleo com três garras
e encaixe central de 1/2" (abertura
máxima: 100 mm), Universal.

SACA FILTRO DE ÓLEO

Chave saca filtro de cinta apolo
verona / escort / logus todos os
motores AP

COD. 0515 485**CHAVE PE DE GALO / GALINHA****COD. 0515 576**

Chave pé de galo 8 pontas quadrada

COD. 0515 577

Chave pé de galinha 7 pontas sextavada

CHAVE DO BUJÃO CARTER RENAULT**COD. 0515 482**

Chave do Bujão do Carter
Renault ponta Quadrada

COD. 0486 018
SACA FILTRO DE ÓLEO (PEQUENA)
DIMENSÕES: ABERTURA MÁXIMA 82 mm
 ABERTURA MÍNIMA 71 mm

EXEMPLOS: VOLKSWAGEM: TODOS C/ MOTOR AP 1.5, 1.6, 1.8, 2.0 (PASSAT, VOYAGE, PARATI, SANTANA, SAVEIRO, GOLF, GOL 1000, GOL 1.8 E 16V)

KIA: PICK-UP CERES. - **GM:** CHEVETTE, HATCH, MARAJÓ, OMEGA 3.0 e 2.0, S-10 C/ MOTOR 4.3, MONZA, KADET, VECTRA GLS/CD, CALIBRA, CORSA.

SUZUKI: TODOS - **FORD:** FIESTA 1.0/1.3 até 96, TAURUS, CURRIER TODOS após 97, FORD KA, ESCORT C/ MOTOR ZETEC. - **TOYOTA:** GEO, LEXUS, SATURN, PASSEO, COROLLA.

NISSAN: SENTRA MÁXIMA, PATHFINDER, PICK-UP - **SUBARU:** LEONE, ROYALE - **HYUNDAI:** ALGUNS MODELOS

MITSUBISHI: ALGUNS MODELOS - **CITROEN:** AX, 2X, XANTIA, FIAT: TIPO 1.6, UNO TURBO após 94, PALIO TODOS.

PEUGEOT: 205, 405, 605, 106, 306, 806 - **DAIHATSU:** TODOS

MAZDA: - **RENAULT:** R19 CLIO após 96 - **HONDA:** ACCORD, CIVIC, CRX e PRELUDES

COD. 0486 019
SACA FILTRO DE ÓLEO (MÉDIA)
DIMENSÕES: ABERTURA MÁXIMA 96 mm
 ABERTURA MÍNIMA 85 mm

EXEMPLOS: **FORD:** D9AZ, 6731 A, CR TODOS C/ MOTOR CHT 16V, MAVERICK 4 CILINDROS.

CRYSLER: DODGE 1800 - **GM:** CARAVAN, OPALA 6 CIL. E 4 CIL., OMEGA 4.1 - **ALFA ROMEO** - **DEUTZ-**
VOLKS: TODOS COM MOTOR CHT 1.6, KOMBI, PICK-UP, DIESEL - **RENAULT:** R21 - **KIA:** ASIA,

 BESTA 2.7 GS, BONGO 3500 - **FIAT:** TODOS INCLUSIVE TEMPRA, FIAT DIESEL, MWM, 6 CIL. -

TRAFIC: DIESEL 2.0 - **TOYOTA:** 90915, 30002, HILUX APÓS 94 - **SCANIA:** SCANIA TURBINA -

PERKINS: 71028, 71054, 71055 - **MWM:** D255/3, D226/4, **MAXION/ROVER.**

COD. 0486 020
SACA FILTRO DE ÓLEO (GRANDE)
DIMENSÕES: ABERTURA MÁXIMA 111 mm
 ABERTURA MÍNIMA 100 mm

EXEMPLOS:
CATERPILLAR: 2P4004/2480996 - **VOLVO:** 6882716

PERKINS: 71029/71058 - **FIAT:** DIESEL/ÔNIBUS

FORD - VW: C/ MOTOR MWM 6.10T, FORD CARGO C/ MOTOR FORD (CAMINHÕES).



COD. 0486 025

SACA FILTRO DE ÓLEO (MÉDIA)**DIMENSÕES:**

ABERTURA MÁXIMA 129 mm

ABERTURA MÍNIMA 118 mm



COD. 0486 026

**SACA FILTRO DE ÓLEO
(SUPER GRANDE)****DIMENSÕES:** ABERTURA MÁXIMA 140 mm
ABERTURA MÍNIMA 129 mm**EXEMPLO:****VOLVO**

**BALDE MANUAL PARA
TROCA DE ÓLEO**

COD. 0486 024
14 Lts. (redondo)

COD. 0486 029
18 Lts. (oval)

PINGADEIRA DE ÓLEO

COD. 0486 003
25 Lts. (sem funis)

**COLETOR DE ÓLEO
COM CARRINHO**

COD. 0486 023
50 Lts.

FUNIS METÁLICOS

Funil de uma curva diferencial (LUB-53)



COD. 0486 032

Funil de duas curvas p/ moto (LUB-54B)



COD. 0486 006

Funil uso geral (LUB-55)

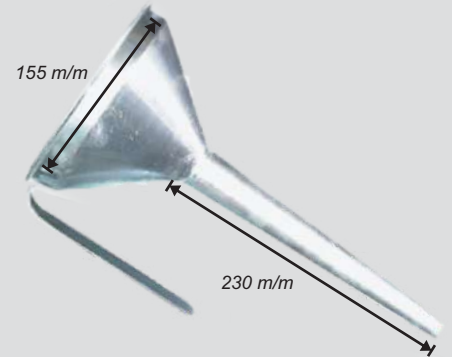

COD. 0486 005

Funil uso geral pequeno (LUB-55B)



COD. 0486 031

Funil uso geral grande (LUB-55C)

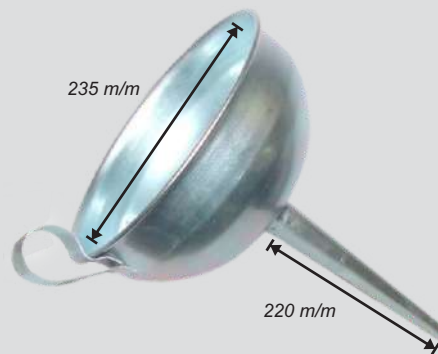

COD. 0486 030

Funil Kombi (LUB-56)

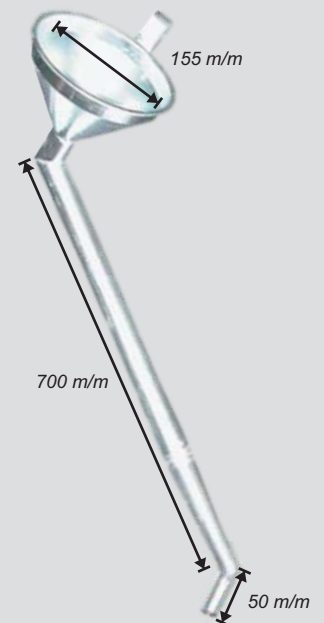

COD. 0486 004

Funil Trator com tela (LUB-57B)



COD. 0486 033

Funil Mercedes Turbinado duas curvas (LUB-58)

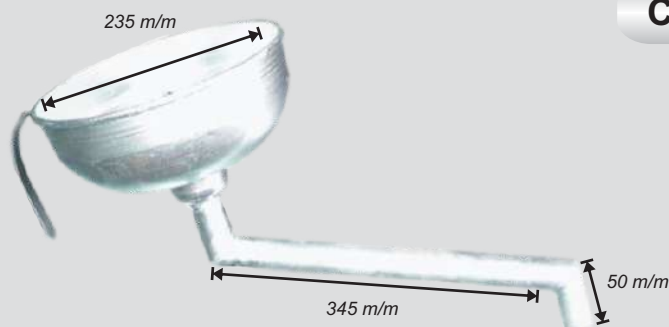

COD. 0486 001

BICO PULVERIZADOR



COD. 0446 101 10
(Alumínio)

Especificações:

- Alumínio;
- Pressão de trabalho 50 - 70 Lbs/Pol - PSI;
- Entrada: 1/4 - BSP
- Peso: 0,175 Kg

BICO DE LIMPEZA



COD. 0446 101 11

Especificações:

- Nylon;
- Pressão de trabalho: A partir de 50 Lbs/Pol;
- Entrada: 1/4 - BSP
- Peso: 0,075 Kg